

零件圖
PARTS LIST

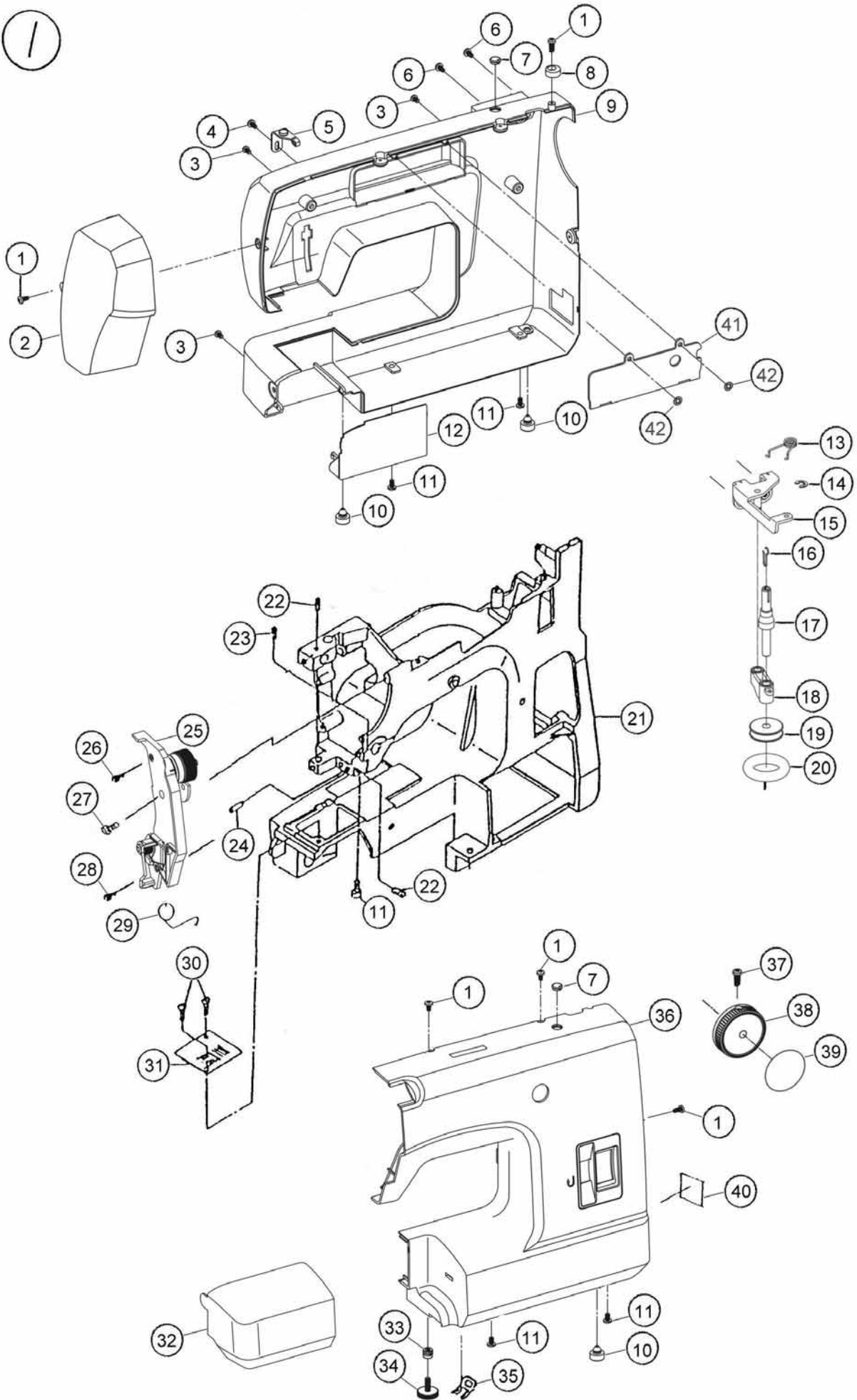

1



ref no.	part no.	name of parts
---	-----	-----
01	000011222	SET SCREW
02	220118000	FACE PLATE
03	301008000	SET SCREW
04	000011211	SET SCREW
05	220501004	THREADER BASE COMP.
06	000016032	SCREW
07	250125058	ADJUSTING HOLE PLUG
08	220062008	BOBBIN STOPER
09	220055008	REAR COVER
10	250020007	RUBBER
11	250087002	SET SCREW
12	220037004	REAR COVER
13	250045008	BOBBIN WINDER SPRING C
14	000000309	SNAP RING 5D
15	220015006	WINDER FIXED PLATE
16	301022000	BOBBIN WINDER SHAFT PIN
17	220014005	BOBBIN CRANK
18	220013004	BOBBIN WINDER
19	353029008	COIL
20	353030002	RUBBER RING
21	250507003	250 ARM/BED
22	301046000	SET SCREW
23	301087003	SET SCREW
24	250013007	LEAD SHAFT
25	220617004	UPPER TENSION COMP.
26	355026001	SET SCREW
27	301008000	SET SCREW
28	260035006	SET SCREW
29	230008007	TENSION CHECK SPRING
30	301261003	SET SCREW
31	250006007	NEEDLE PLATE
32	220036003	EXTENSION TABLE PLATE
33	220060006	NUT
34	250023103	ADJUSTING FOOT
35	353049004	PANEL FIXATION
36	22012xxxxx	FRONT COVER (DRAWING)
37	370048006	HINGED SCREW
38	260027038	SELECTOR DIAL
39	xxxxxxxxxx	SELECT DIAL INDICATED PLATE
40	xxxxxxxxxx	RATING PLATE
41	220061007	HANDLE COVER
42	000012201	SNAP RING

2

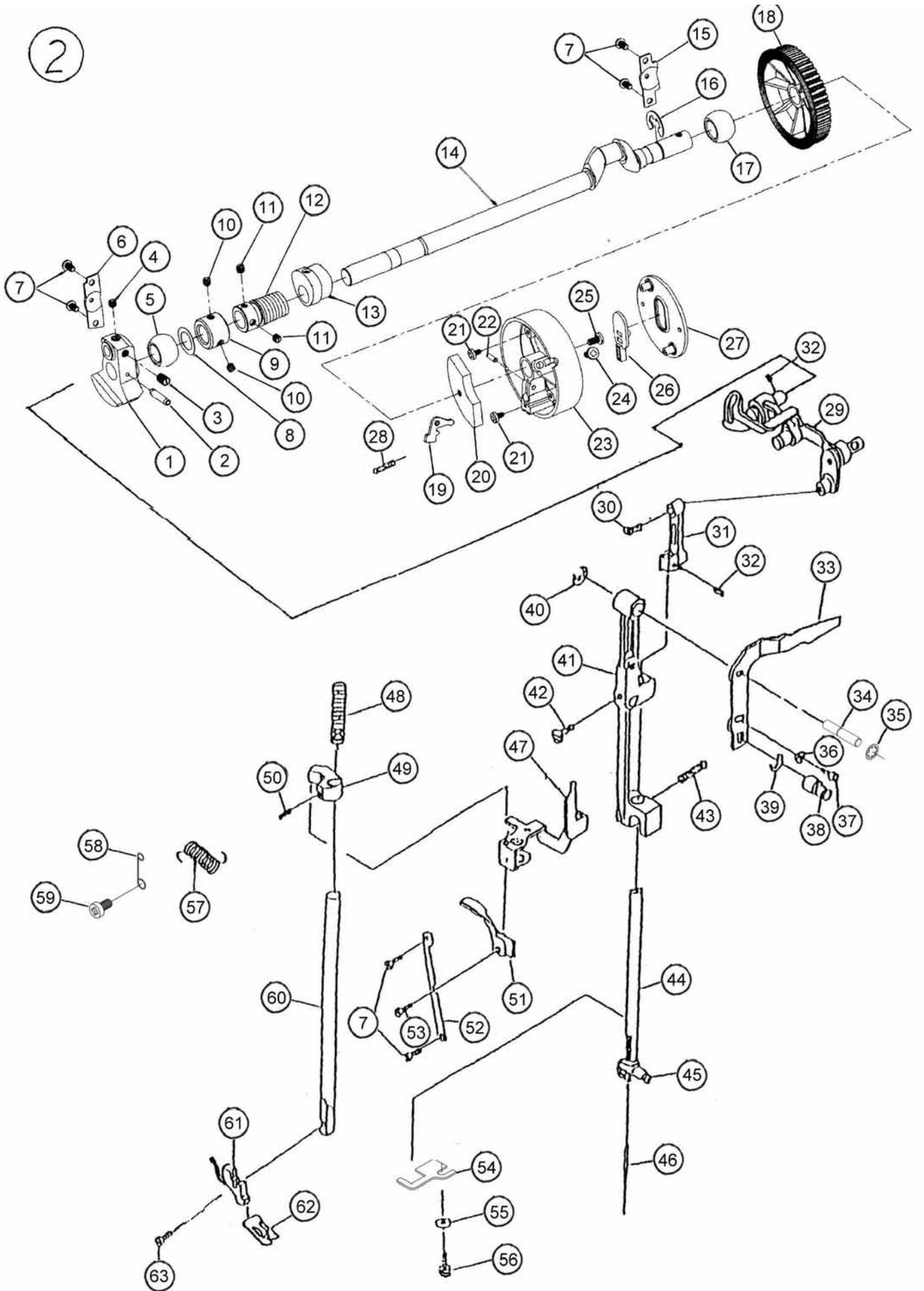

ref no.	part no.	name of parts
---	-----	-----
01	301083009	THREAD TAKE-UP CRANK
02	000003508	SPRING PIN 4*20
03	301084000	SET SCREW
04	301068008	SET SCREW
05	250002003	FRONT BUSHING
06	250004005	FRONT BUSHING BRACKET
07	301008000	SET SCREW
08	301086002	NYLON WASHER
09	301340306	COLLAR
10	301087003	SET SCREW
11	301093002	UPPER SHAFT SET SCREW
12	370040204	UPPER SHAFT GEAR
13	370504005	SELECT CAM COMP
14	220001009	UPPER SHAFT
15	250005006	REAR BUSHING BRACKET
16	000000907	E RING UPPER SHAFT
17	250002003	FRONT BUSHING
18	220002000	MOTOR BELT
19	220004002	WHEEL TRANSPORT PLATE
20	220008006	BALANCE PLATE
21	000011222	SET SCREW
22	220005003	TRANSPORT PIN
23	220003012	HAND WHEEL
24	000016032	SCREW
25	2500087002	SET SCREW
26	220006015	CLUTCH BUTTON
27	220007016	WHEEL COVER
28	610100000	SPRING
29	301544003	TAKE-UP LEVER CAMP
30	301100003	SET SCREW
31	301503000	NEEDLE HOLDER
32	301046000	SET SCREW
33	370011000	ZIGZAG DRIVING PLATE
34	220028002	SUPPORTER
35	000012326	RING
36	301245001	WASHER
37	301016001	SET SCREW
38	301045009	ECCENTRIC PIN
39	000000206	SNAP RING 4D
40	000000309	SNAP RING 5D
41	250089004	NEEDLE BAR SUPPORTER
42	301016001	SET SCREW
43	301047001	SPRING
44	260042006	NEEDLE BAR
45	260502009	NEEDLE CLAMP COMP
46	301244206	NEEDLE
47	230010002	TENSION RELEASE LEVER *A
48	290026007	SPRING
49	301252001	GUIDE BRACKET
50	301087003	SET SCREW
51	370154006	PRESSER BAR LIFTER
52	250007008	PRESSURE BAR LIFTER
53	301070003	HINGED SCREW
54	220030007	NEEDLE BAR STOPPING PLATE
55	301245001	WASHER
56	301049003	SET SCREW
57	370147006	SPRING
58	271094007	TENSION SPRING SETTER
59	301037008	SET SCREW
60	301061001	PRESSER BAR
61	301522005	PRESSER FOOT HOLDER
62	353012008	ZIGZAG PRESSER FOOT
63	610012004	SET SCREW

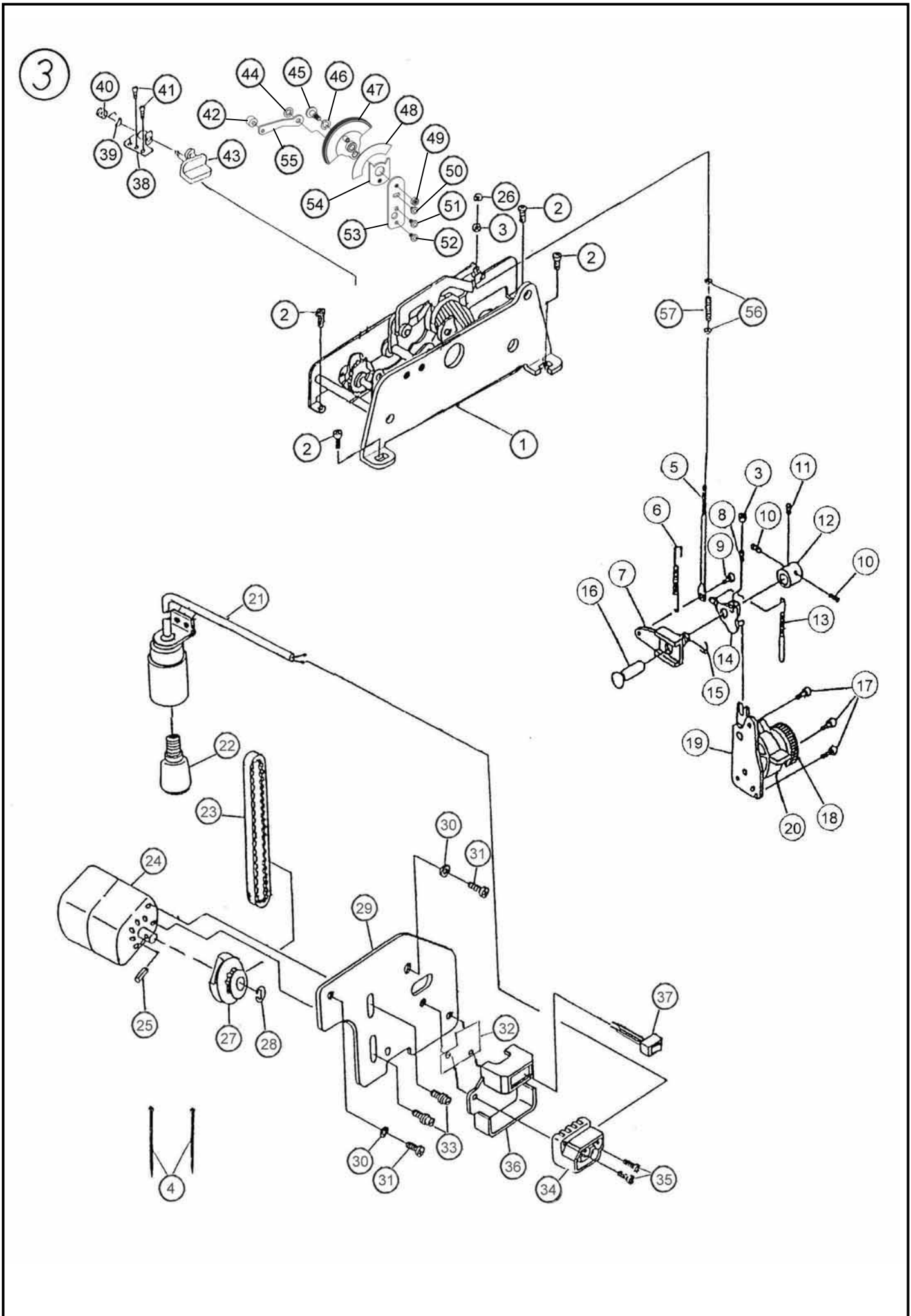

ref no. ---	part no. -----	name of parts -----
01	220605412	PATTERN COMP.
02	301008000	SET SCREW
03	301151009	NUT
04	351047006	BAND
05	370042000	STRETCH STITCH ROD
06	301155003	SPRING
07	250081109	ADJUSTER
08	301289007	SET SCREW
09	301154002	HINGED SCREW
10	301046000	SET SCREW
11	301087003	SET SCREW
12	301153104	COLLAR
13	370045003	SPRING
14	270284003	ADJUSTING PLATE
15	000000505	SNAP RING 9D
16	301152000	FEED REGULATOR SHAFT
17	301008000	SET SCREW
18	230003714	STITCH LENGTH DIAL
19	270655xxx	STITCH LENGTH DIAL COMP.
20	380024052	REVERSE BUTTON
21	220801007	LIGHT CORD COMP.
22	650816103	LIGHT BULB
23	301285106	BELT
24	230813003	MOTOR COMP.
25	000003807	SPRING PIN 2*14
26	250146000	NUT
27	301555007	MOTOR WHEEL COMP.
28	000000103	SNAP RING 3D
29	260025003	MOTOR BRACKET
30	450063008	SPRING WASHER
31	301143008	SET SCREW
32	260050007	INSULATED PLATE
33	000063023	SET SCREW
34	000063034	RECEPTACLE
35	000063001	SCREW
36	260026037	SWITCH FIXED PLATE
37	250831009	SWITCH COMP
38	250012006	ZIGZAG MECHANISM
39	000000206	SNAP RING 4D
40	380058000	SPRING
41	301008000	SET SCREW
42	301207001	SHAFT
43	380057009	CONNECTING CRANK
44	000012201	SNAP RING 4D
45	000030009	SET SCREW
46	000013109	WAVE WASHER
47	220026000	ZIGZAG DIAL
48	220067025	ZIGZAG DIAL INDICATED PLATE
49	000004015	NUT
50	000016009	SCREW
51	000016010	SCREW
52	000016010	SCREW
53	220027001	ZIGZAG DIAL SUPPORTER
54	220031008	ZIGZAG LIMIT BOARD
55	220032009	ZERO MOVED CRANK
56	370044002	WASHER
57	370043001	ROD SPRING

4

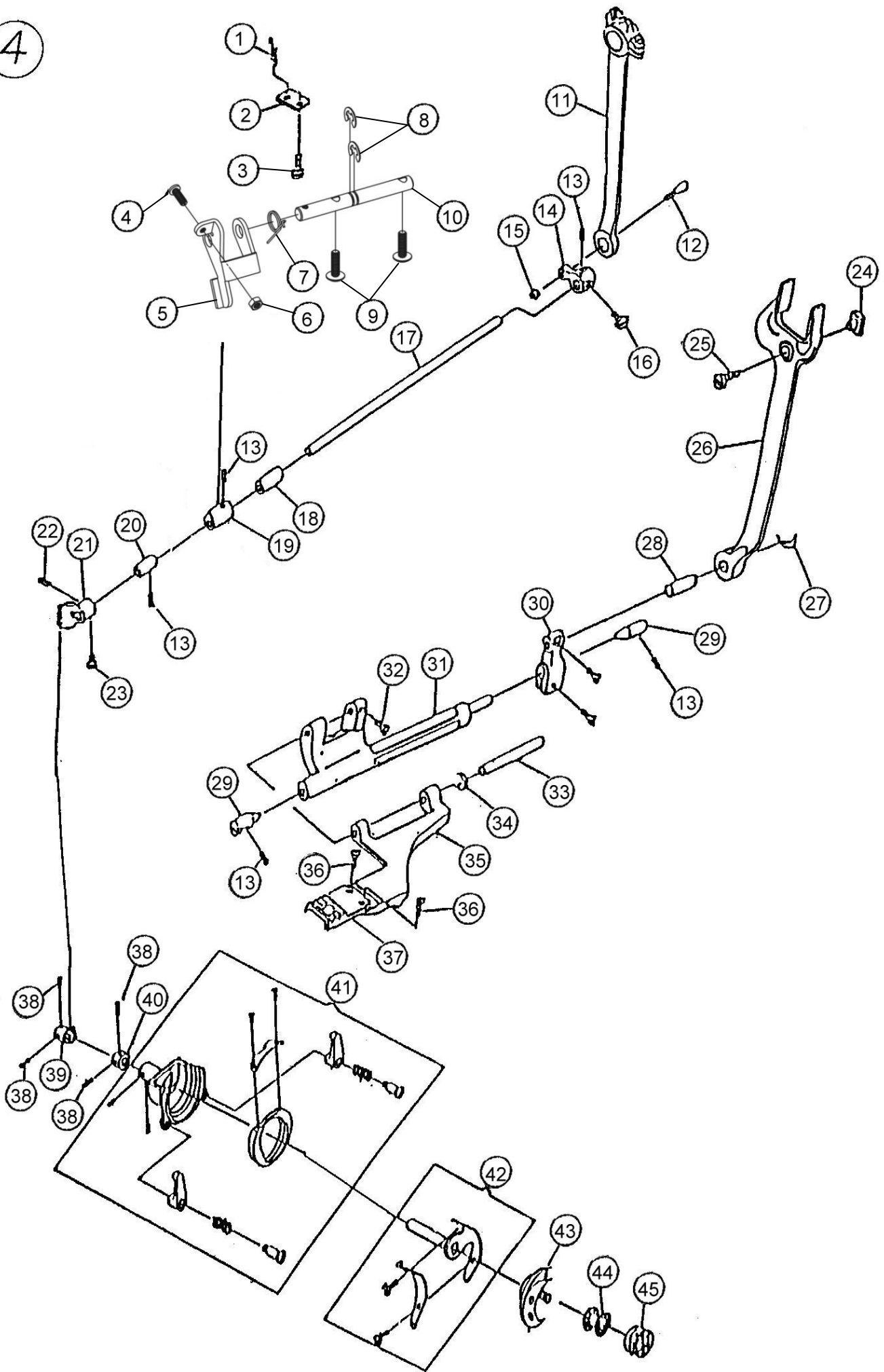

ref no. ---	part no. -----	name of parts -----
01	301181008	FEED DOG BASE SPRING
02	301197007	SPRING HOLDER
03	301185002	SET SCREW
04	220012003	SET SCREW
05	220011002	DROP FEED CRANK
06	301151009	NUT
07	301195005	SPRING
08	000003009	SNAP RING 5D
09	250010004	SET SCREW
10	220010001	UP/DOWN SHAFT
11	301512002	CRANK ROD COMP
12	301106009	TAPER SCREW
13	301087003	SET SCREW
14	353014000	LOWER SHAFT BRACKET
15	301107000	NUT
16	000018045	SCREW
17	301109002	LOWER SHAFT
18	301110006	LOWER SHAFT FRONT BUSHING
19	301182102	FEED LIFTING CAM
20	301111100	LOWER SHAFT REAR BUSHING
21	301113010	OSCILLATING SHAFT GEAR
22	301115001	SET SCREW
23	301114000	SET SCREW
24	301147002	FORKED ROD SLIDE BLOCK
25	301146001	FORKED ROD SLIDE BLOCK DRAFT
26	301145000	FORKED ROD
27	000000402	SNAP RING 6D
28	301179003	CONNECTING PIN
29	301241007	CENTER PIN B
30	301517007	FEED ROCK CRANK
31	301171005	FEED ROCK SHAFT
32	301131003	SET SCREW
33	301173007	FEED DOG BASE SHAFT
34	000000206	SNAP RING 4D
35	301172006	FEED DOG BASE
36	301175009	SET SCREW
37	301174008	FEED DOG
38	301046000	SET SCREW
39	301130116	BEVEL GEAR
40	301129101	COLLAR
41	301542207	HOOK RACE BODY COMP.
42	301541000	HOOK RACE SHAFT COMP.
43	301132406	HOOKPANEL
44	610081004	BOBBIN
45	301515304	BOBBIN CASE

5

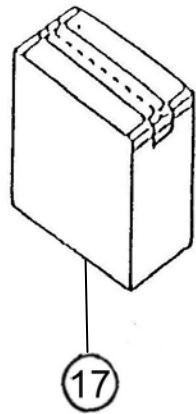
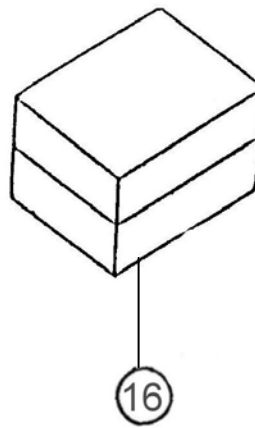
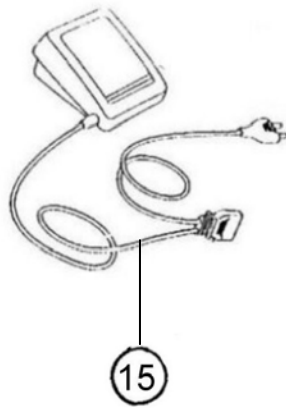
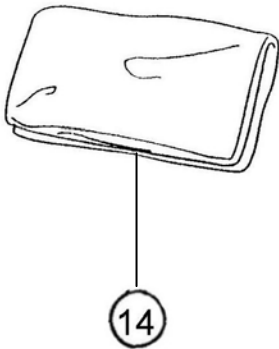
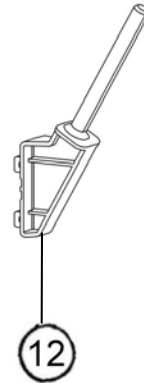
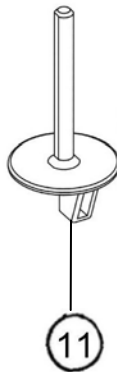
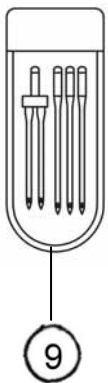
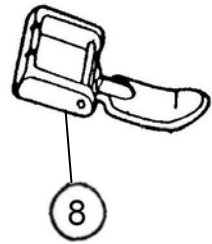
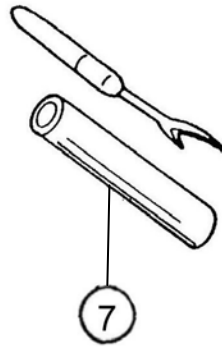
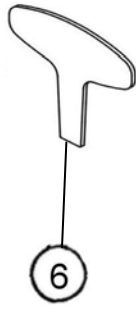
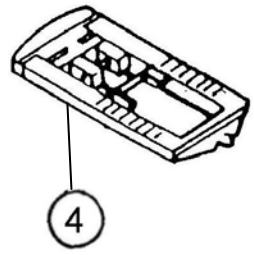
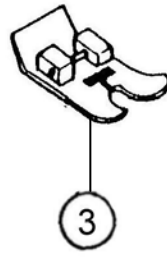

ref no. ---	part no. -----	name of parts -----
01	610081004	BOBBIN
02	301403009	FELT
03	353012008	ZIGZAG PRESSER FOOT
04	303401003	BUTTONHOLE FOOT
05	301439004	SCREW DRIVER (L)
06	660403001	SCREW DRIVER
07	303403201	BUTTONHOLE KNIFE
08	301438003	ZIPPER FOOT
09	270660502	NEEDLE BAG COMP.
10	220401003	FEED COVER PLATE
11	220405007	SPOOL PIN (A)
12	220406008	SPOOL PIN (B)
13	xxxxxxxxx	INSTRUCTION MANUAL
14	353435805	DUST COVER
15	230814004	CONTROLLER COMP.
16	220402004	POLYFOAM COMP
17.	xxxxxxxxx	CARTON



HSM-2221

高林股份有限公司 KAULIN MFG. CO., LTD.